



AV7350 1000

WHY RAMEX HOSE REELS , PERCHÈ UN AVVOLGITUBO RAMEX

■ SAVE TIME	■ RISPARMIO DI TEMPO
■ SAVE MONEY	■ RISPARMIO DI DENARO
■ INCREASED SAFETY	■ SICUREZZA SUL LAVORO
■ LONG HOSE DURABILITY	■ INCREMENTA LA DURATA DEL TUBO
■ EFFICIENCY IN DAILY WORK	■ EFFICIENZA NEL LAVORO QUOTIDIANO
■ 100% MADE IN ITALY	■ MADE IN ITALY 100%

WHERE TO USE , DOVE UTILIZZARLO



PROPER USE , CORRETTO UTILIZZO

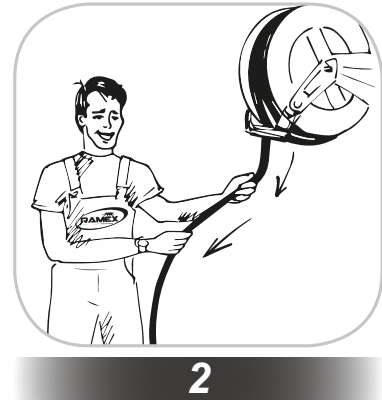

RAMEX

video

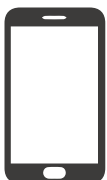



AV7350 1000

TECHNICAL FEATURES › CARATTERISTICHE TECNICHE

AV 7350 1000 AISI 304

Admitted diameters Diametri ammessi	1/4"
Hose lenght in meters Lunghezza tubo	Up to 35 mt 1/4" Fino a 35 mt 1/4"
Working pressure Pressione lavoro	Up to 1000 bar / Fino a 1000 bar
Working Temperature Temperatura lavoro	90°C
Inlet thread size Connessione Ingresso	3/8" M
Outlet thread size Connessione uscita	1/2" F
Weight Peso	38 kg
Packing size Dimensione imballo	340x610x660 mm
Raw material sides and roll Materiali costruttivi rullo e fiancate	AISI 304
Raw material shaft and swivel joint Materiali costruttivi perno e giunto	AISI 303
Raw material main spring Materiale molla principale	Carbon Steel Acciaio al carbonio
Can be used to transfer Adatto all'utilizzo con	Air Water Chemical Aria Acqua Prodotti Chimici
Included Accessories Accessori inclusi	Hose bumper (1/4") and nipple (1/4") Palla finecorsa (1/4") e nipplo (1/4")

AV7350 1000 AISI 316

Admitted diameters Diametri ammessi	1/4"
Hose lenght in meters Lunghezza tubo	Up to 35 mt 1/4" Fino a 35 mt 1/4"
Working pressure Pressione lavoro	Up to 1000 bar / Fino a 1000 bar
Working Temperature Temperatura lavoro	90°C
Inlet thread size Connessione Ingresso	3/8" M
Outlet thread size Connessione uscita	1/2" F
Weight Peso	38 kg
Packing size Dimensione imballo	340x610x660 mm
Raw material sides and roll Materiali costruttivi rullo e fiancate	AISI 316
Raw material shaft and swivel joint Materiali costruttivi perno e giunto	AISI 316
Raw material main spring Materiale molla principale	Carbon Steel Acciaio al carbonio
Can be used to transfer Adatto all'utilizzo con	Air Water Chemical Aria Acqua Prodotti Chimici
Included Accessories Accessori inclusi	Hose bumper (1/4") and nipple (1/4") Palla finecorsa (1/4") e nipplo (1/4")

AV7350 1000 FE

Admitted diameters Diametri ammessi	1/4"
Hose lenght in meters Lunghezza tubo	Up to 35 mt 1/4" Fino a 35 mt 1/4"
Working pressure Pressione lavoro	Up to 1000 bar / Fino a 1000 bar
Working Temperature Temperatura lavoro	90°C
Inlet thread size Connessione Ingresso	3/8" M
Outlet thread size Connessione uscita	1/2" F
Weight Peso	38 kg
Packing size Dimensione imballo	340x610x660 mm
Raw material sides and roll Materiali costruttivi rullo e fiancate	Carbon Steel Acciaio al carbonio
Raw material shaft and swivel joint Materiali costruttivi perno e giunto	AISI 303
Raw material main spring Materiale molla principale	Carbon Steel Acciaio al carbonio
Can be used to transfer Adatto all'utilizzo con	Air Water / Aria Acqua On request Oil Grease Su richiesta Olio Grasso
Included Accessories Accessori inclusi	Hose bumper (1/4") and nipple (1/4") Palla finecorsa (1/4") e nipplo (1/4")

AV7350 1000 CA

Admitted diameters Diametri ammessi	1/4"
Hose lenght in meters Lunghezza tubo	Up to 35 mt 1/4" Fino a 35 mt 1/4"
Working pressure Pressione lavoro	Up to 1000 bar / Fino a 1000 bar
Working Temperature Temperatura lavoro	90°C
Inlet thread size Connessione Ingresso	3/8" M
Outlet thread size Connessione uscita	1/2" F
Weight Peso	38 kg
Packing size Dimensione imballo	340x610x660 mm
Raw material sides and roll Materiali costruttivi rullo e fiancate	Carbon Steel Acciaio al carbonio
Raw material shaft and swivel joint Materiali costruttivi perno e giunto	AISI 303
Raw material main spring Materiale molla principale	Carbon Steel Acciaio al carbonio
Can be used to transfer Adatto all'utilizzo con	Air Water / Aria Acqua On request Oil Grease Su richiesta Olio Grasso
Included Accessories Accessori inclusi	Hose bumper (1/4") and nipple (1/4") Palla finecorsa (1/4") e nipplo (1/4")

RAMEX



AV7350 1000

EXPLODED VIEW › ESPLOSO

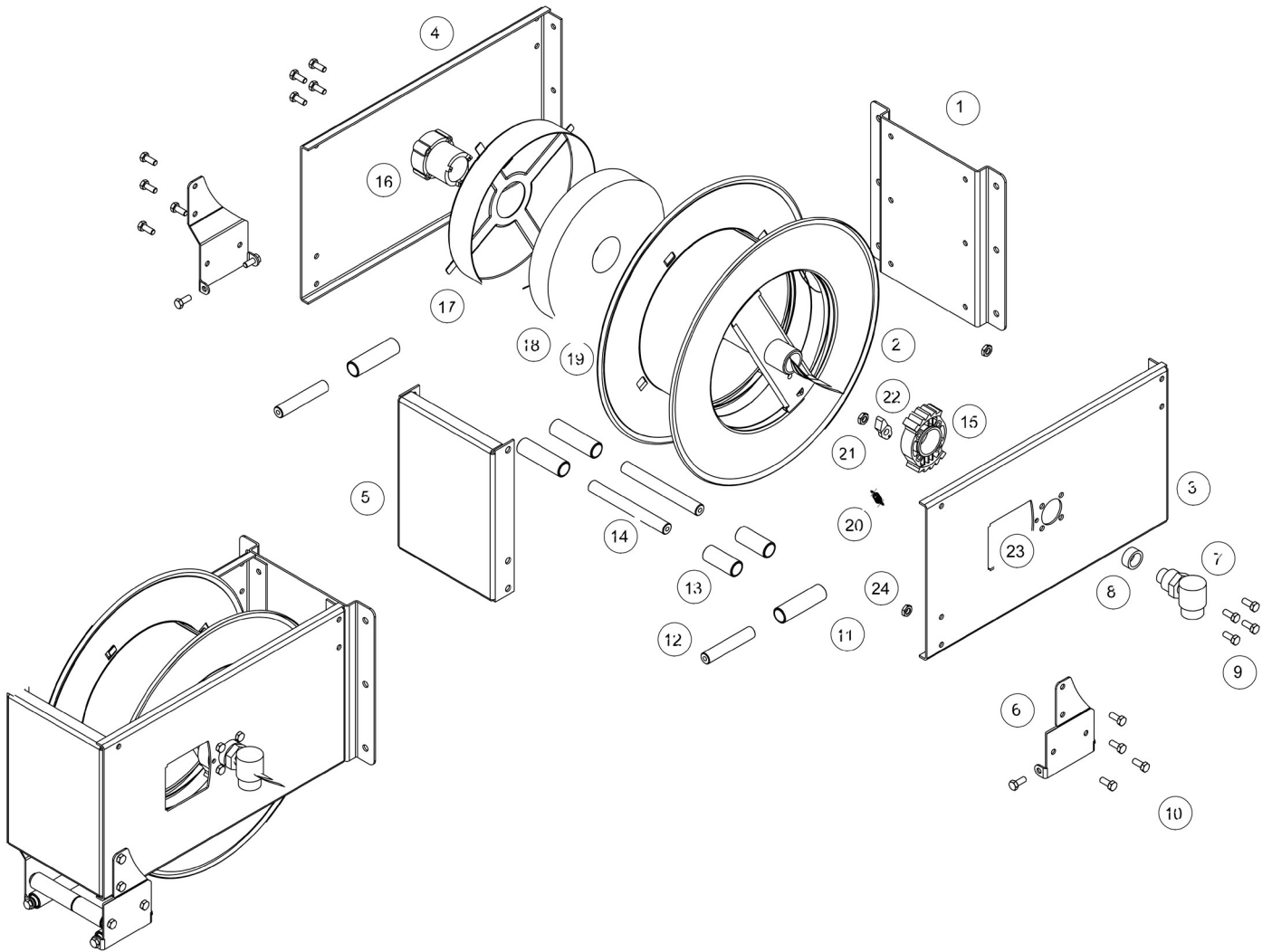



AV7350 1000

EXPLODED VIEW › ESPLOSO

POS	Description and quantity / Descrizione e quantità	AV 7350 1000	AV 7350 1000 316	AV 7350 1000 FE CA	
1	Base (1x)				
2	Reel / Bobina (1x)				
3	Side (swivel side) / Fiancata (girevole) (1x)				
4	Side (spring side) / Fiancata (molla) (1x)				
5	Top / Base superiore (1x)				
6	Roller / Rullino (1x)				
7	Roller / Rullino (1x)				
8	Swivel joint / Giunto girevole (1x)	49-1000	49-1000 316	49-1000	
10	Screw / Vite (8x)				
13	Screw / Vite (12x)				
14	Vertical roller / Rullino verticale (2x)				
15	Vertical rod / Tirante verticale (2x)				
9	Horizontal roller / Rullino orizzontale (2x)				
11	Horizontal rod / Tirante orizzontale (2x)				
12	Rack / Cremagliera (1x)	KIT CR 1	KIT CR 1	KIT CR 1	
17	Hub / Mozzo (1x)	KIT 92	KIT 92 316	KIT 92	
23	Spring case / Padellotto portamolla (1x)				
16	Spring / Molla (1x)				
18	Plastic separator / Distanziale in plastica (1x)				
19	Plastic ratchet / Plastic ratchet (1x)	KIT 93	RC 10	KIT 93	RC 10
20	Ratchet screw + nut M10 / Vite per salterello + dado M10 (1x)		RC 20		RC 20
21	Ratchet spring / Molla per salterello (1x)		KIT 12		KIT 12 316
22	Plastic cover (with screw) / Copertura in plastica (con vite) (1x)				
24	Nut / Dado (10x)				



AV7350 1000

DIMENSIONAL DRAWING › DISEGNO DIMENSIONALE

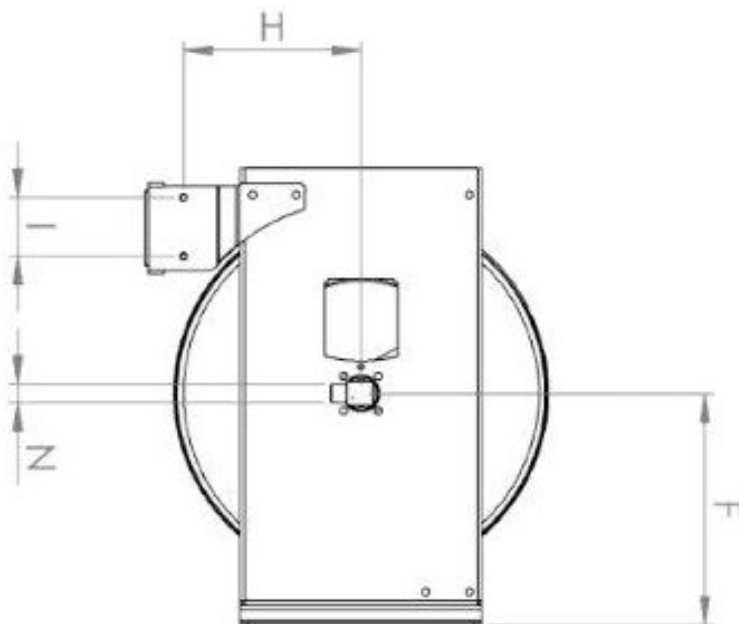
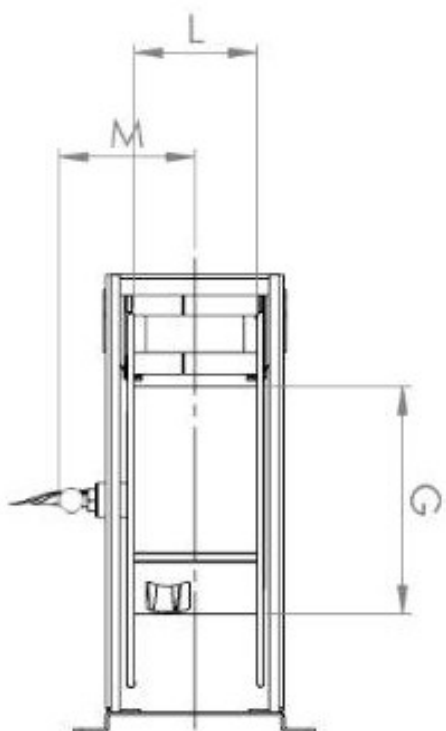
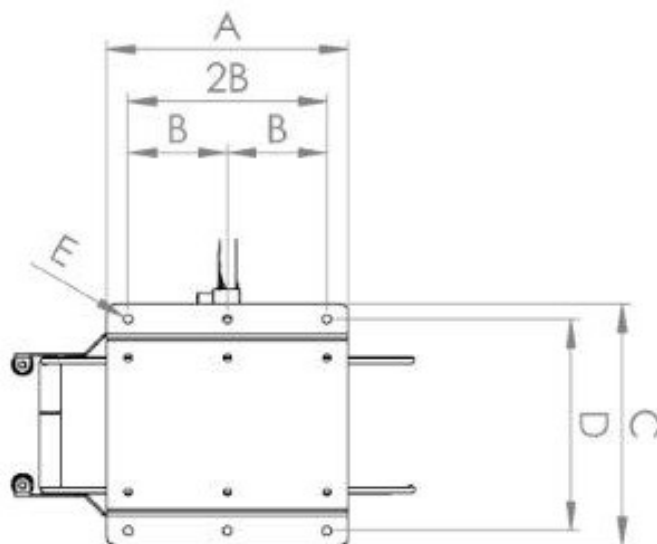

ART.	A	B	C	D	E	F	G	H	I	L	M	N
AV 7350 1000	330 mm	140 mm	280 mm	244 mm	13 mm	325 mm	300 mm	230 mm	80 mm	150 mm	160 mm	½"



AV7350 1000

INCLUDED ACCESSORIES › ACCESSORI INCLUSI

HOSE REEL AVVOLGITUBO	NIPPLE NIPPLO
AV 7350 1000	1/2"-1/4" stainless steel nipple with washer Nipplo in acciaio inox 1/2"-1/4" con rondella
AV 7350 1000 316	
AV 7350 1000 FE	
AV 7350 1000 CA	

OPTIONAL ACCESSORIES › ACCESSORI OPTIONAL

HOSE TUBO
69 1/4" 

 <http://ramex.com.ru> 8 (800) 707-66-48

 ramex@ramex.com.ru +7 (495) 540-45-68